

IDF/Rack Room

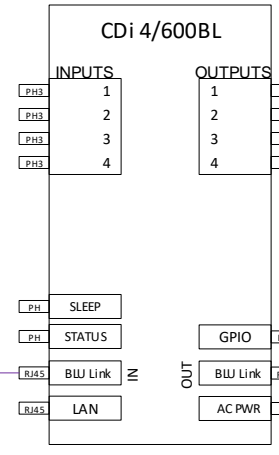

LOBBY  
HALL  
ELEVATORS  
GYM  
RESTROOMS  
OUTDOOR - DRIVE-UP AND LANDSCAPE

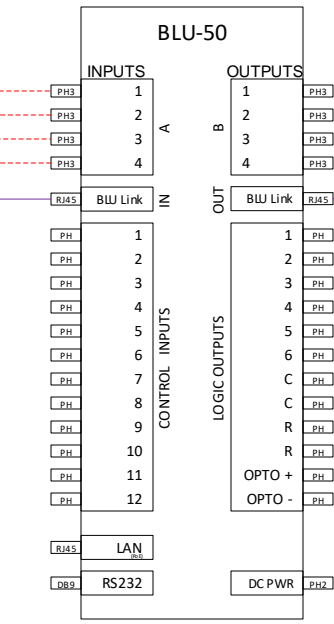
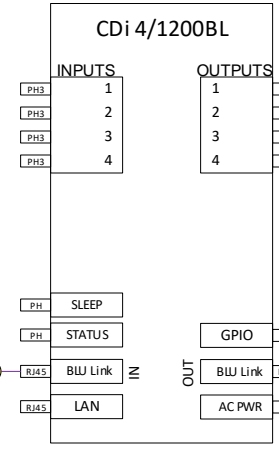
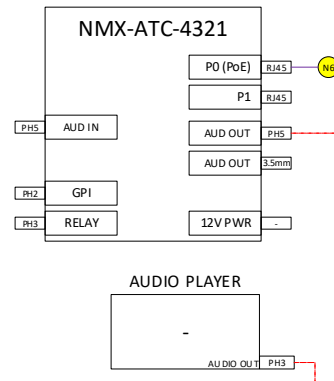
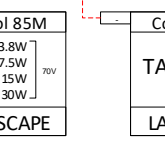
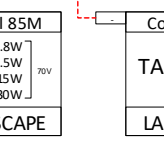
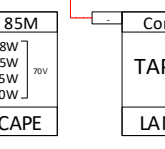
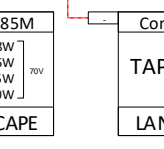
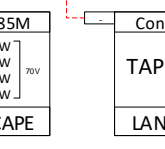
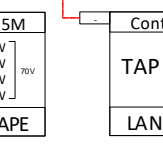
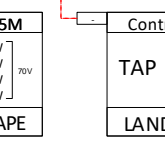
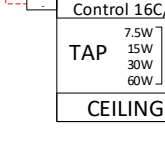
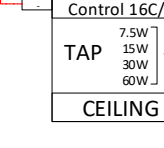
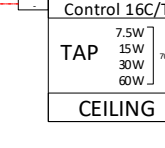
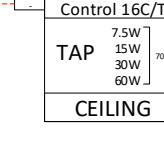
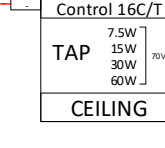
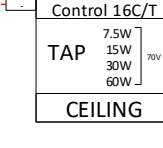
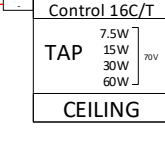
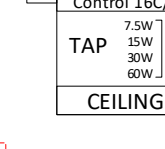
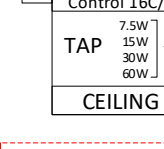
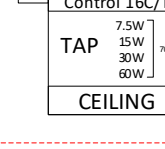
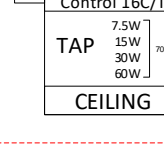
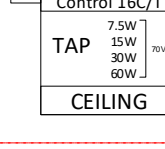
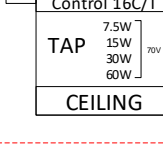
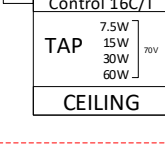
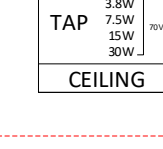
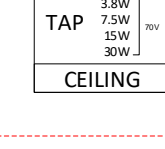
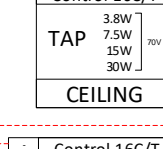
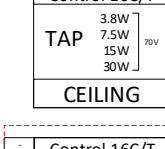
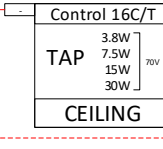
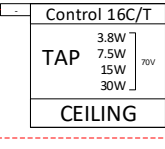
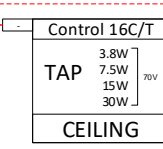
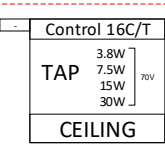
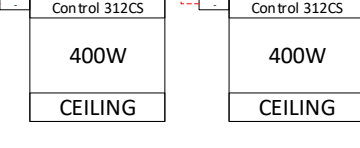
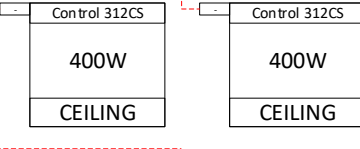
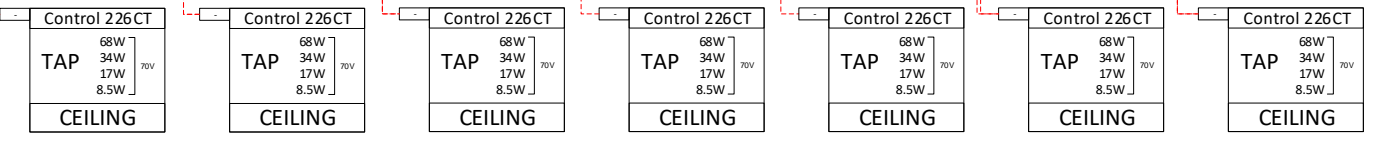
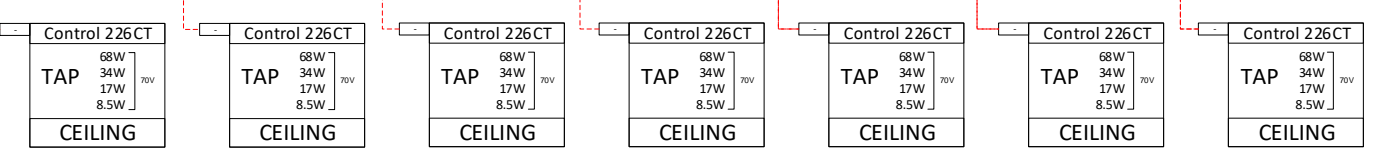

Hotel Lobby/Foyer/  
Huddle Space

Notes

Notes	Rev	DATE
	0	

ISSUE DATE: 03/23/2018

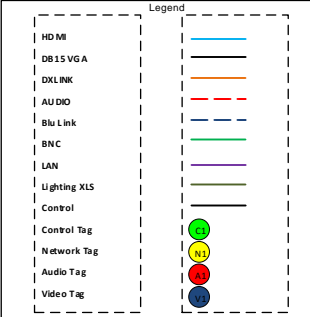

PROJECT ENGINEER: Harman  
DRAWN BY: Harman

DRAWING NUMBER  
Audio  
AV-01  
© 2018 Harman Professional

# Hotel Lobby/Foyer/ Huddle Space

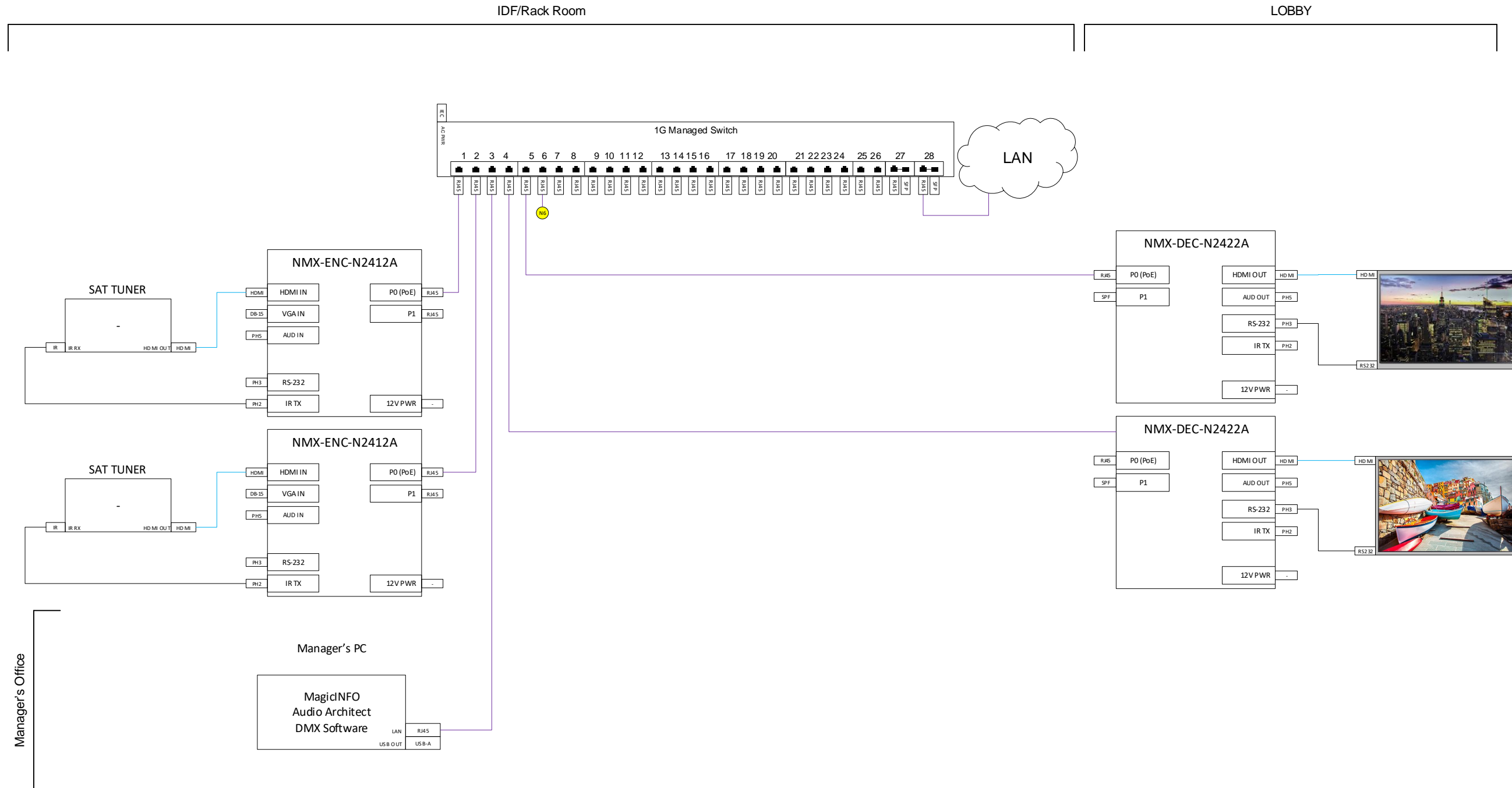

### Notes

Notes	Rev	DATE
	0	

ISSUE DATE: 03/23/2018

PROJECT ENGINEER: Harman  
DRAWN BY: Harman

DRAWING NUMBER  
Video  
AV-02  
© 2018 Harman Professional

# Hotel Lobby/Foyer/ Huddle Space

IDF/Rack Room

Manager's Office

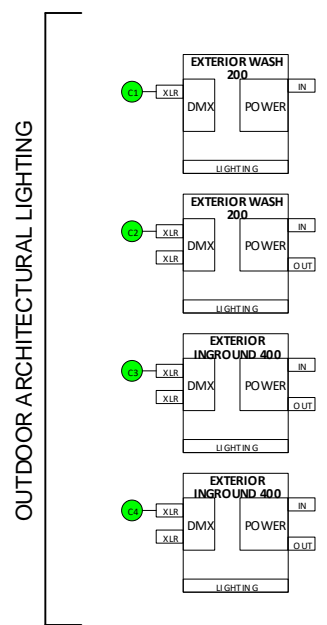
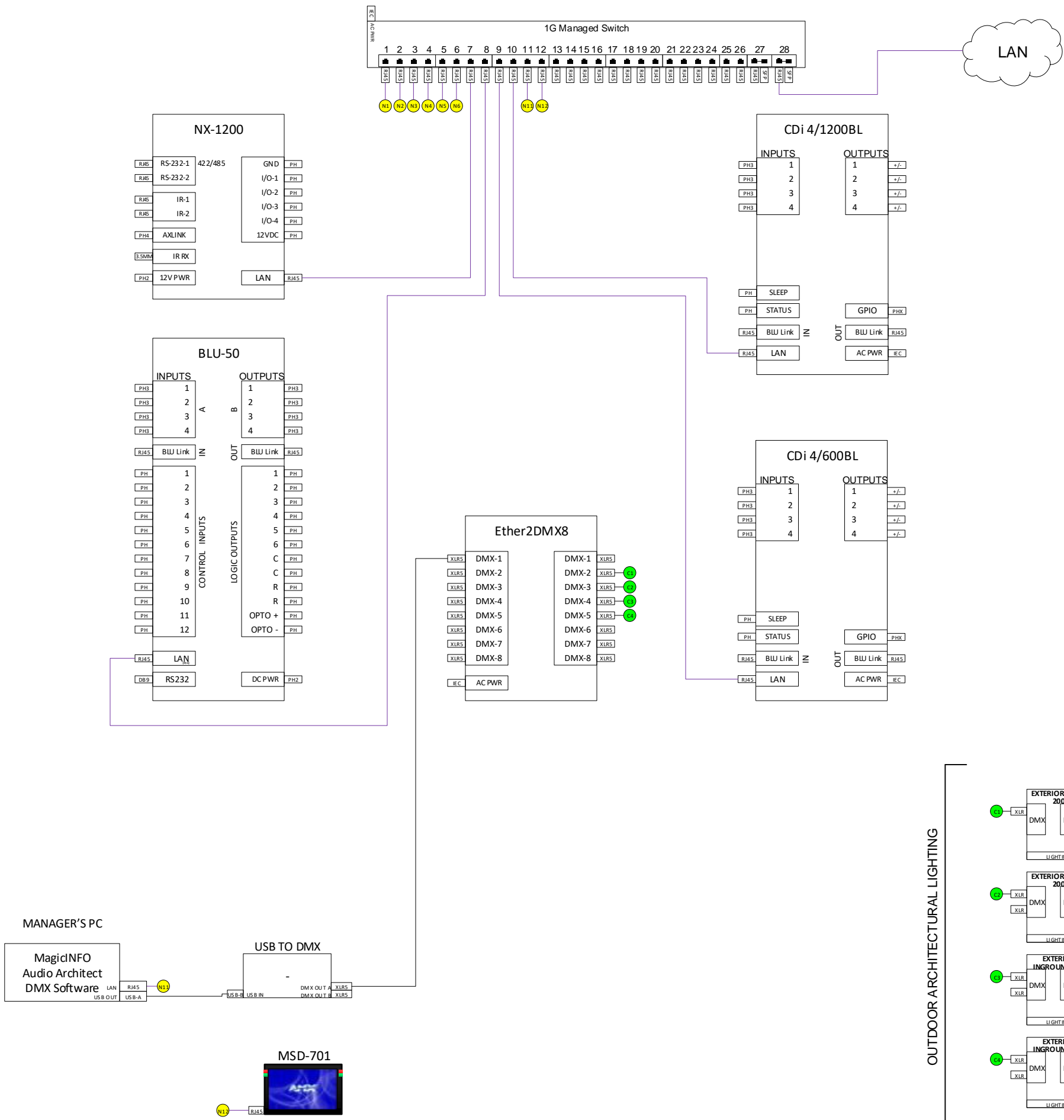

OUTDOOR ARCHITECTURAL LIGHTING

### Notes

Notes	Rev	DATE
	0	

ISSUE DATE: 03/23/2018

Legend	
HD MR	
DB15 VG A	
DXLINK	
AU/DIO	
B/W Link	
BNC	
LAN	
Lighting XLS	
Control	
Control Tag	
Network Tag	
Audio Tag	
Video Tag	

PROJECT ENGINEER: Harman  
DRAWN BY: Harman

DRAWING NUMBER  
Lighting/Control  
**AV-03**  
© 2018 Harman Professional

**Hotel Lobby/Foyer/  
Huddle Space**

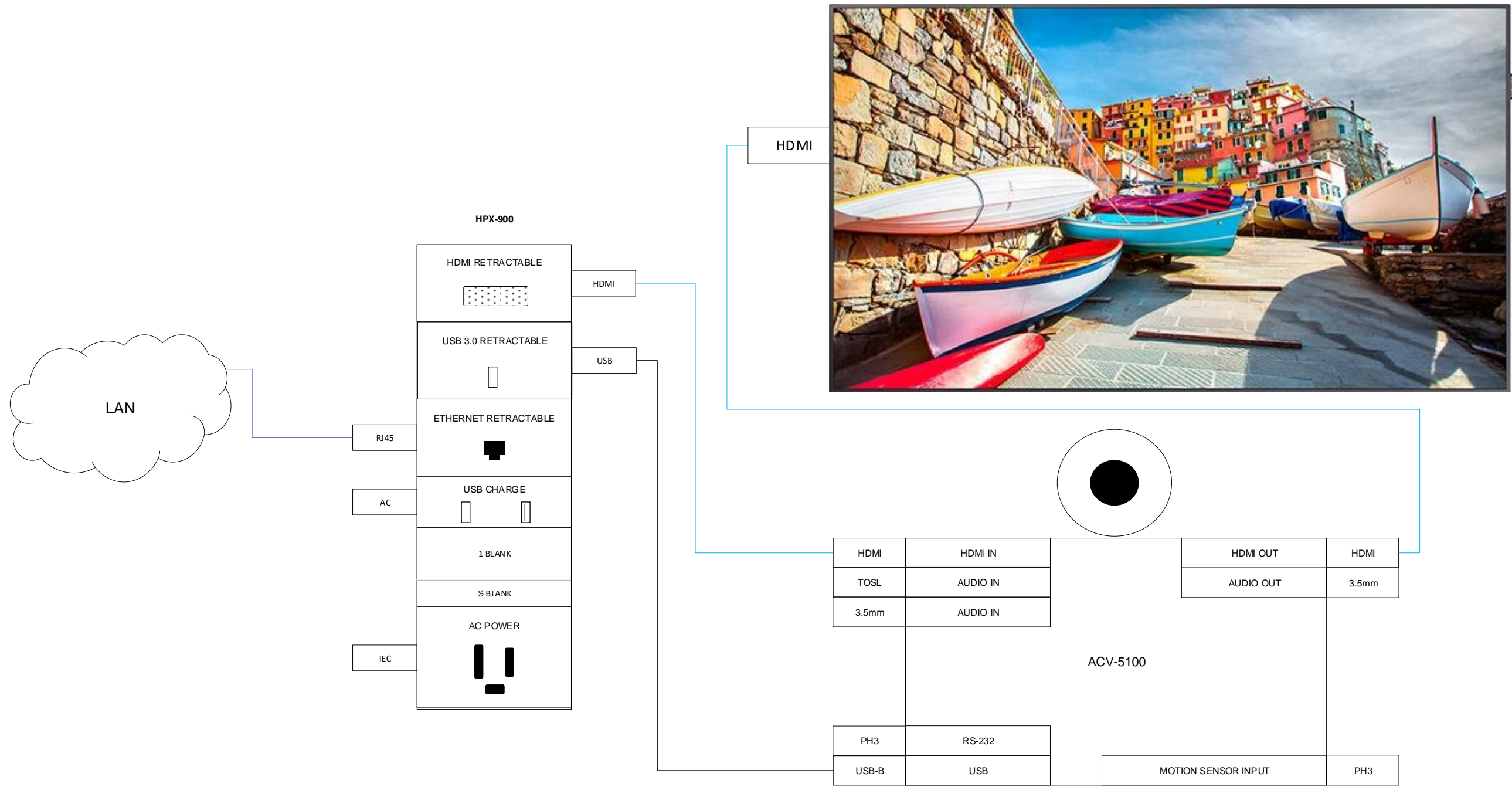

**Notes**

Notes	Rev	DATE
	0	

ISSUE DATE: 03/23/2018

Legend

HDMI	Blue line
DB15 VGA	Black line
DXLINK	Red line
AU/DI	Green line
Blu Link	Blue dashed line
BNC	Green dashed line
LAN	Purple line
Lighting XLS	Black line
Control	Green circle
Control Tag	Yellow circle
Network Tag	Red circle
Audio Tag	Blue circle
Video Tag	Blue circle

PROJECT ENGINEER: Harman  
DRAWN BY: Harman

**DRAWING NUMBER**  
Huddle Space  
**AV-04**  
© 2018 Harman Professional