

# House of Worship

## Small Congregation

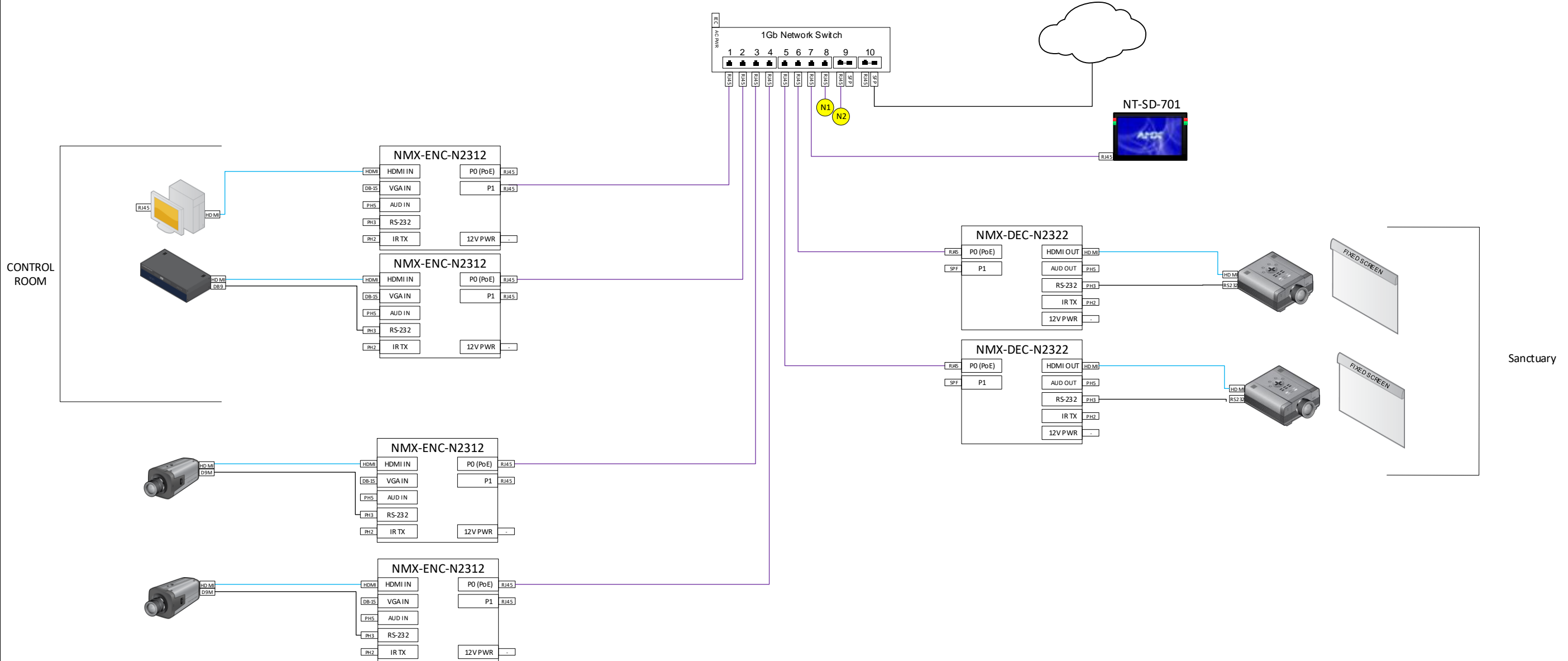

Sanctuary

CONTROL ROOM

### Notes

| Notes | Rev | DATE    |
|-------|-----|---------|
|       | 0   | 3/23/18 |
|       |     |         |
|       |     |         |
|       |     |         |

ISSUE DATE:

|              |  |
|--------------|--|
| HDMI         |  |
| DB15 VGA     |  |
| DXL INK      |  |
| AUDIO        |  |
| Blu Link     |  |
| BNC          |  |
| LAN          |  |
| Lighting XLS |  |
| Control      |  |
| Control Tag  |  |
| Network Tag  |  |
| Audio Tag    |  |
| Video Tag    |  |

PROJECT ENGINEER: Harman  
 DRAWN BY: Harman  
 OPPORTUNITY  
 NUMBER:

DRAWING NUMBER  
**V-01**  
 © 2017 Harman Professional

# House of Worship

Small Congregation

WIRELESS MIC'S

STAGE MONITORS

COLUMN SPEAKERS

PRX 812W

CBT 70J-1 + 70JE-1

GROUND SUPPORT SUBWOOFER

ASB 6112

Assisted Listening System

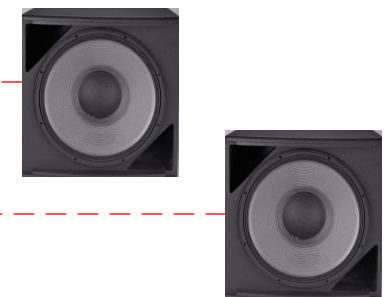
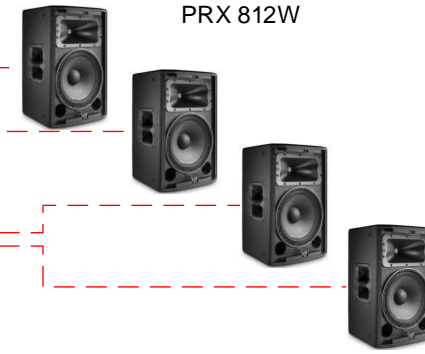
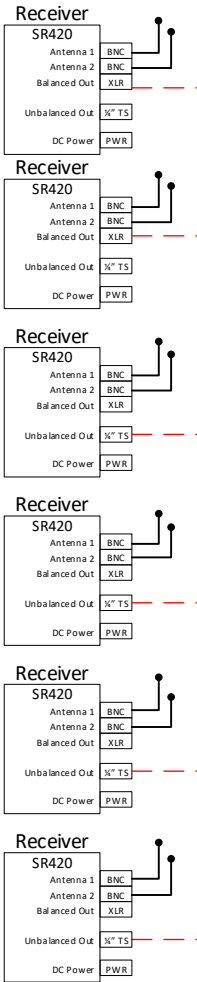
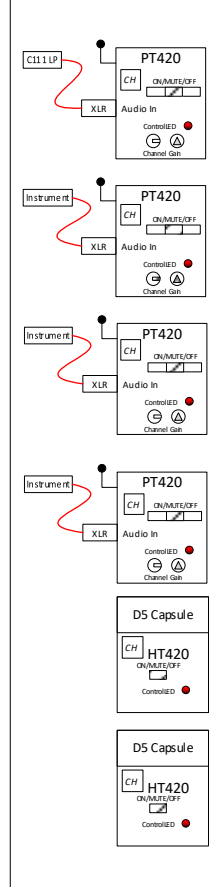
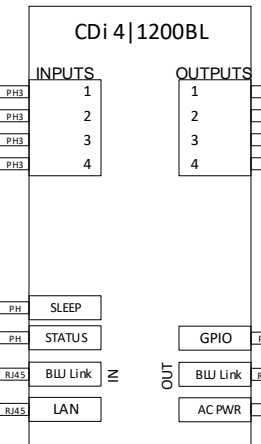
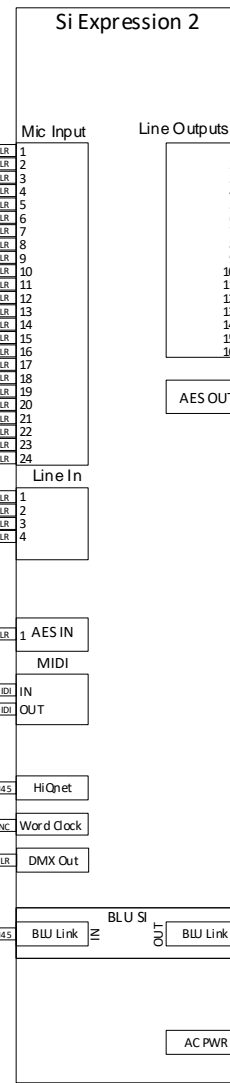
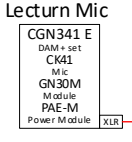
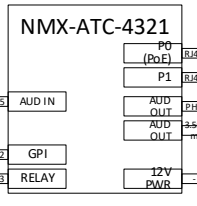

Notes

| Notes | Rev | DATE    |
|-------|-----|---------|
|       | 0   | 3/23/18 |
|       |     |         |
|       |     |         |
|       |     |         |

ISSUE DATE: 3/23/2018

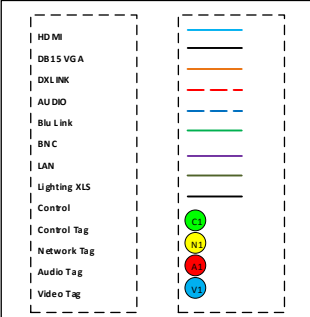

PROJECT ENGINEER: Harman  
DRAWN BY: Harman  
OPPORTUNITY NUMBER:

DRAWING NUMBER  
**A-01**  
© 2017 Harman Professional