

# Auditorium Hybrid

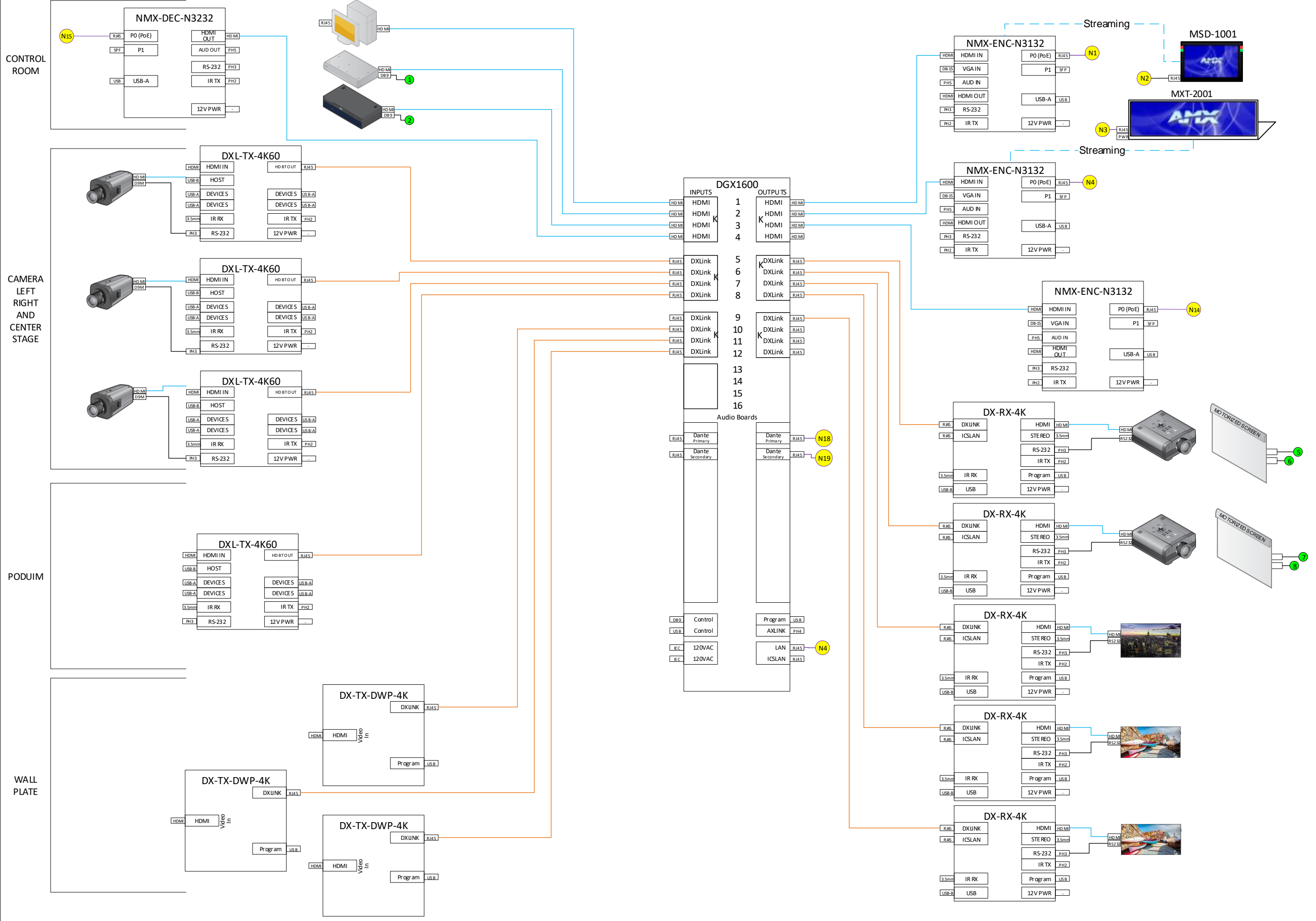

### Notes

Notes	Rev	DATE
Initial	0	8/31/17
ESS	1	7/11/18

ISSUE DATE: 9/1/2017

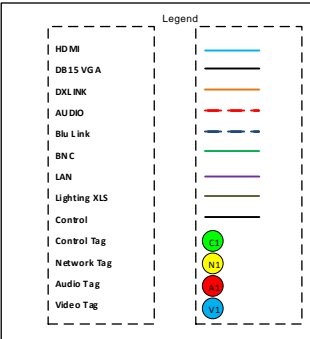

PROJECT ENGINEER: Harman  
DRAWN BY: Harman

DRAWING NUMBER  
**V-01**  
© 2018 Harman Professional

# Auditorium Hybrid

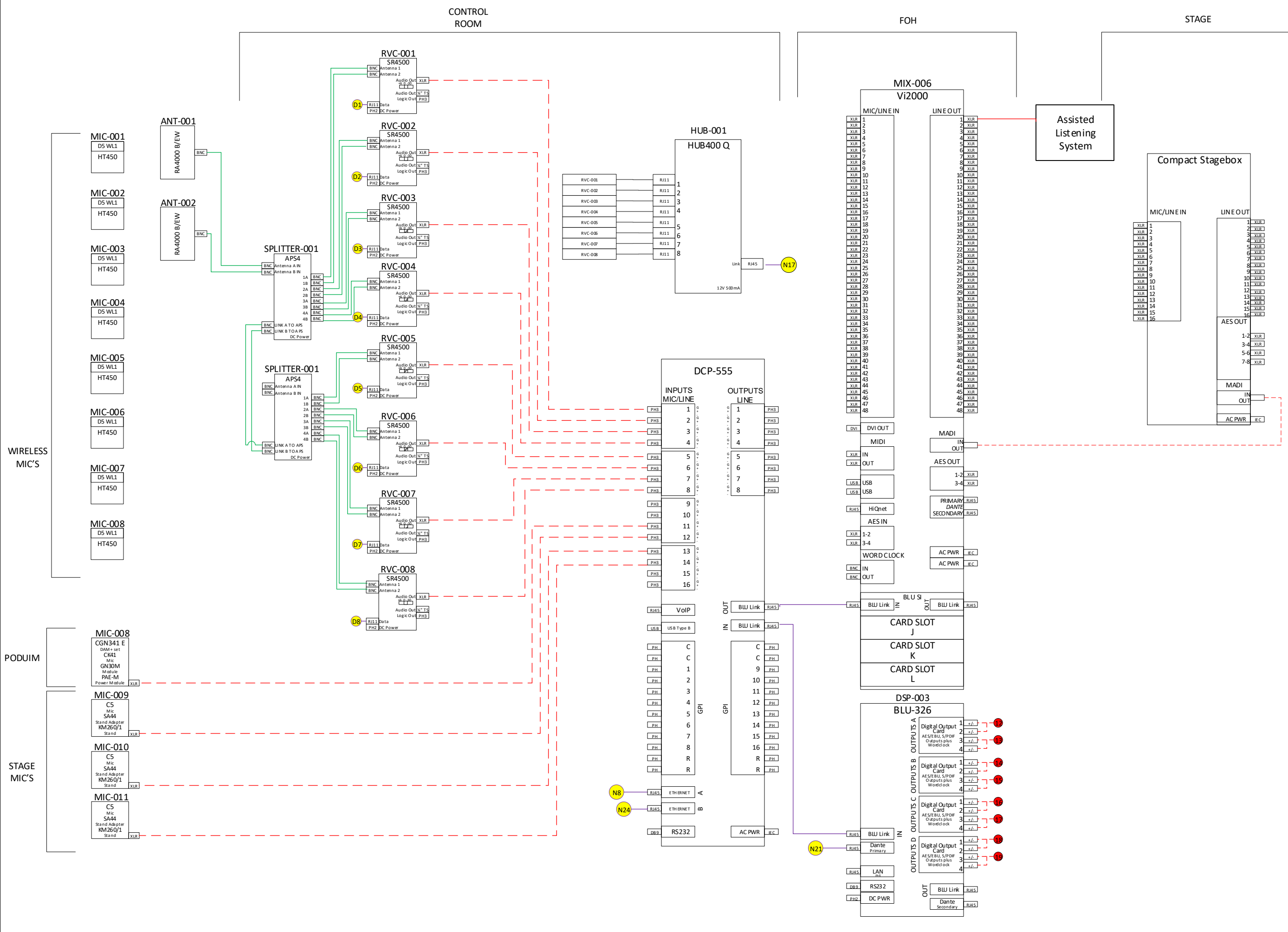

### Notes

Notes	Rev	DATE
Initial	0	8/31/17
ESS	1	7/11/18

ISSUE DATE: 9/1/2017

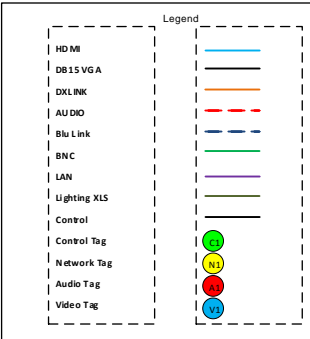

PROJECT ENGINEER: Harman  
DRAWN BY: Harman

DRAWING NUMBER  
**A-01**  
© 2017 Harman Professional

# Auditorium Hybrid

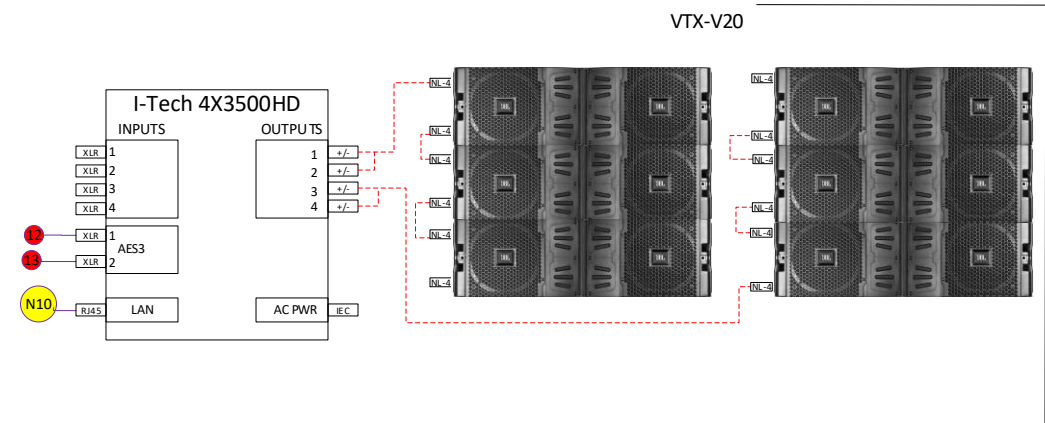

MAIN LEFT ARRAY

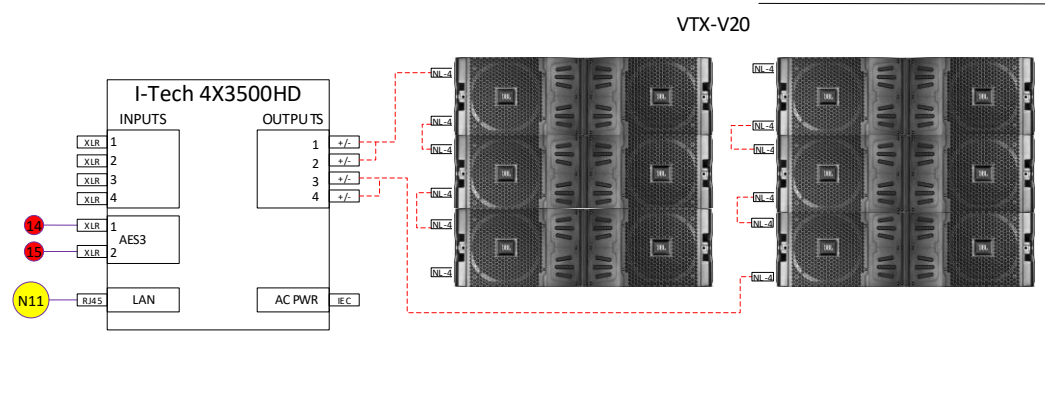

MAIN RIGHT ARRAY

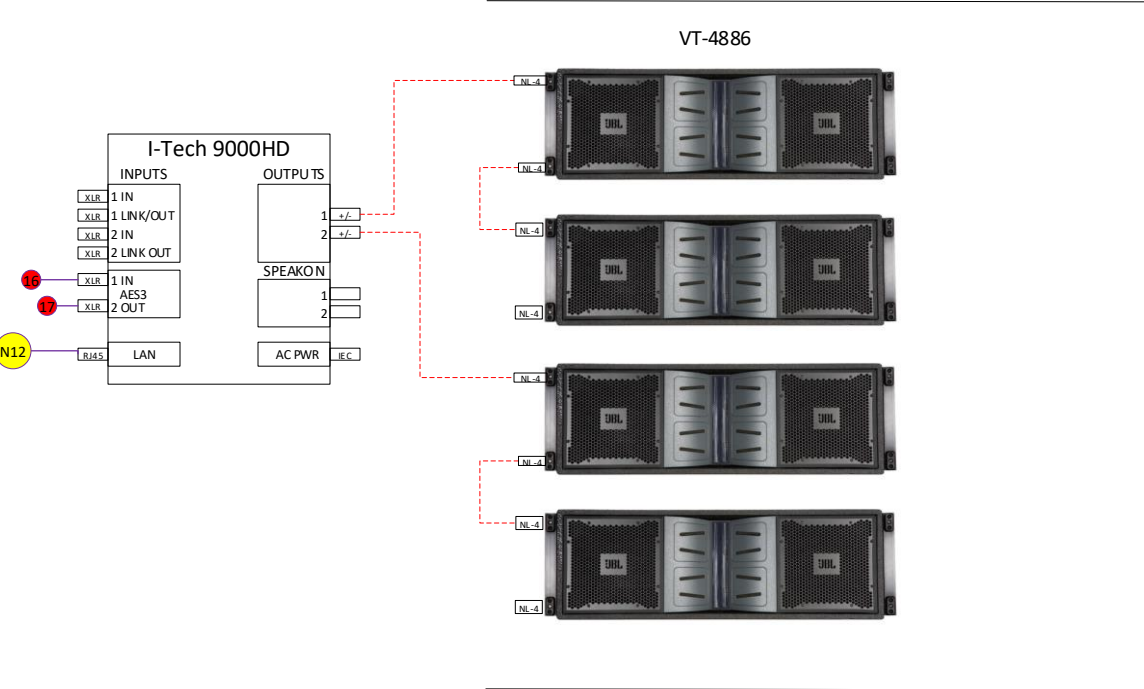

FLOWN CENTER FILL ARRAY

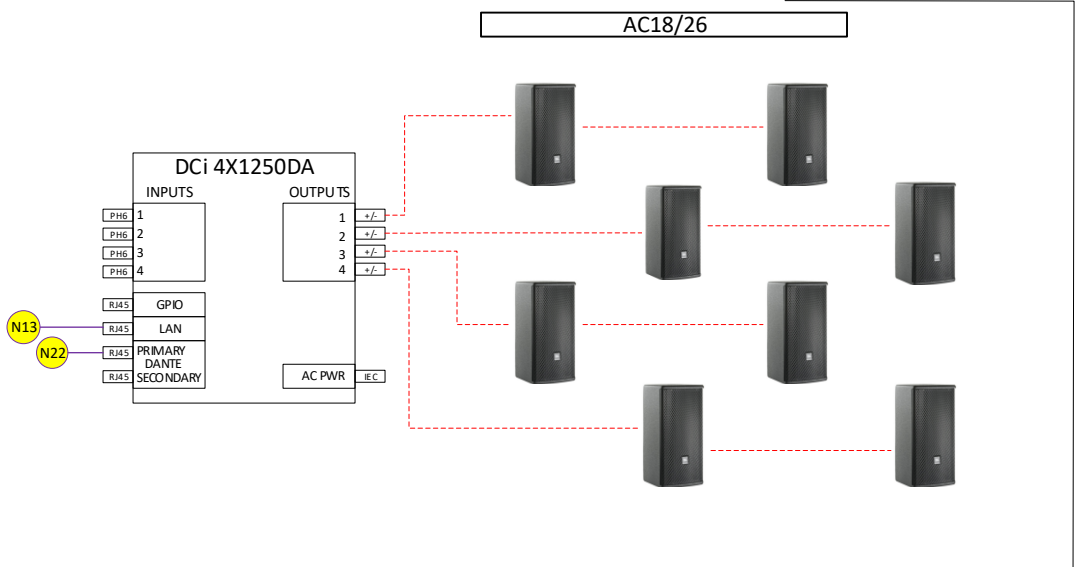

STAGE LIP PROXIMITY SYSTEM

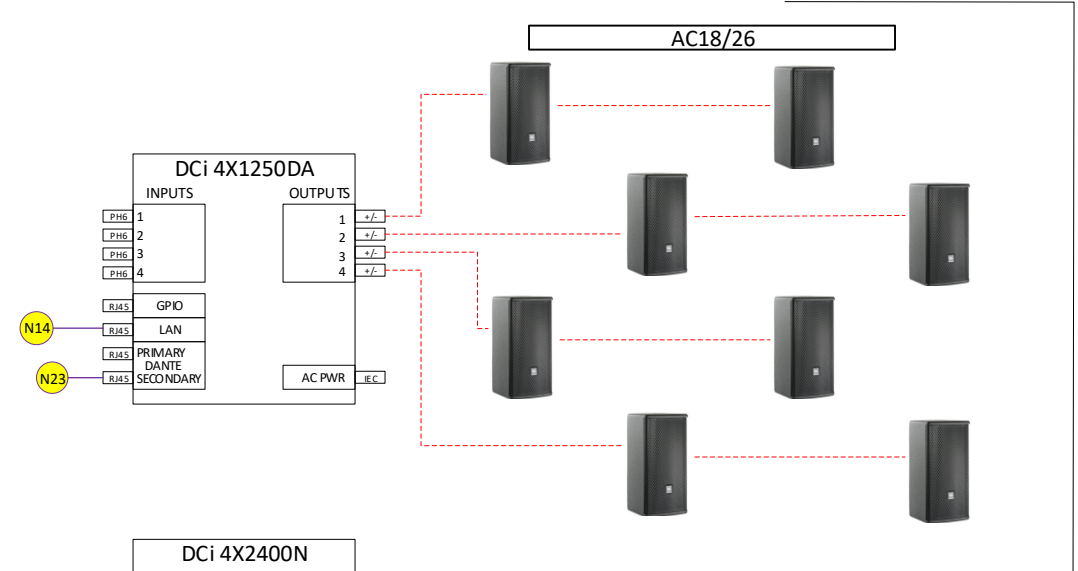

UNDER BALCONY DELAY SYSTEM

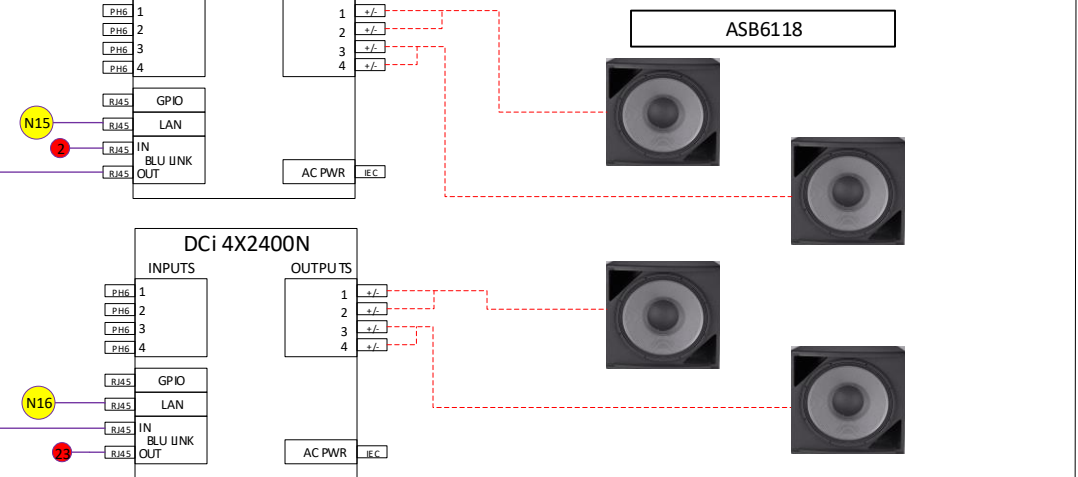

GROUND SUPPORT SUBWOOFERS

### Notes

Notes	Rev	DATE
Initial	0	8/31/17
ESS	1	7/11/18

ISSUE DATE: 9/1/2017

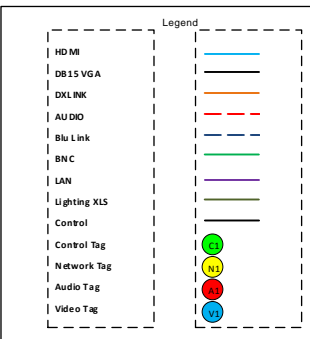

PROJECT ENGINEER:  
DRAWN BY:

DRAWING NUMBER

A-02

© 2017 Harman Professional

# Auditorium Hybrid

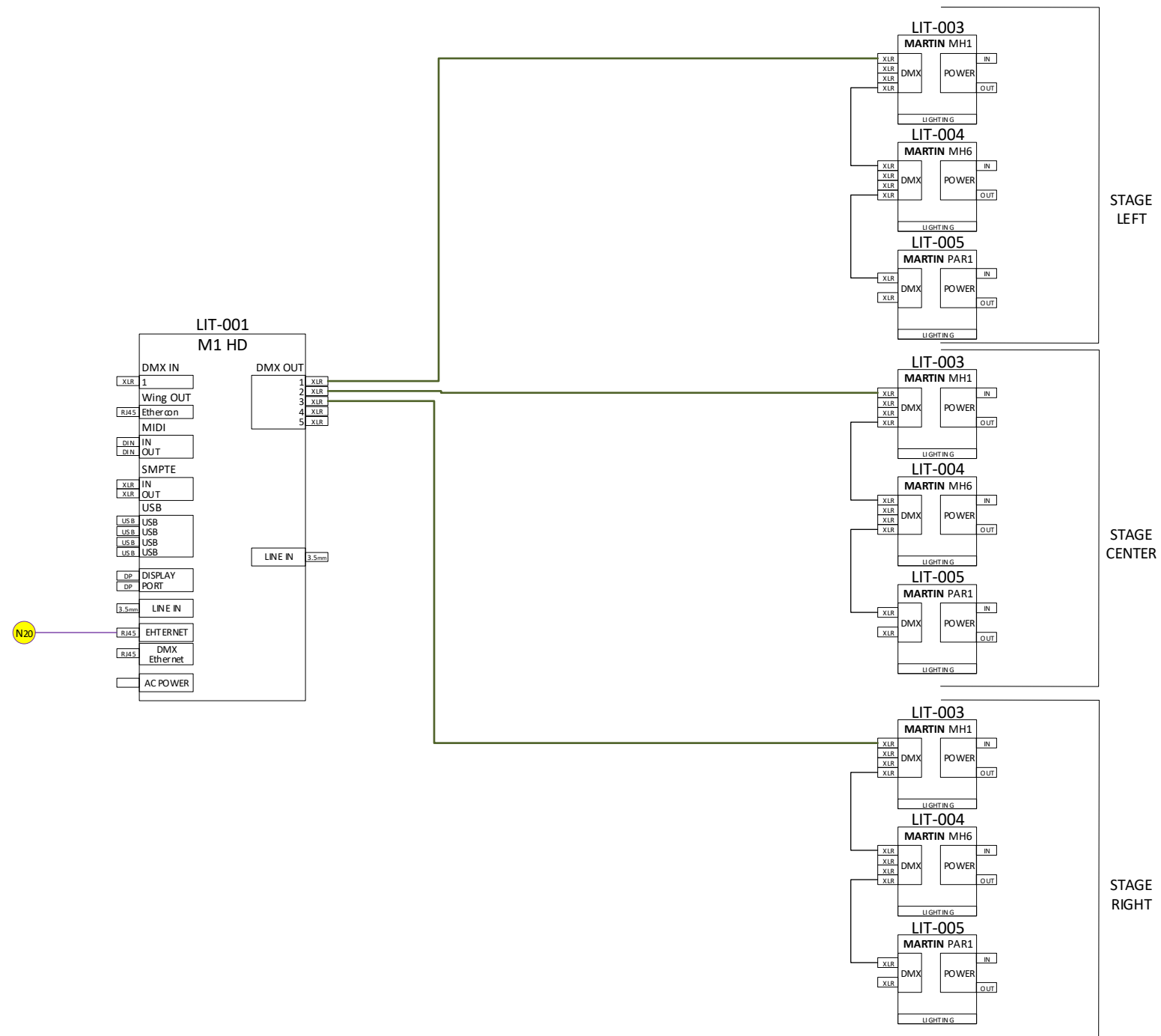

### Notes

Notes	Rev	DATE
Initial	0	8/31/17
ESS	1	7/11/18

ISSUE DATE: 9/1/2017

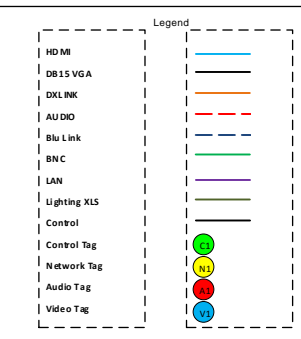

PROJECT ENGINEER:  
DRAWN BY:

DRAWING NUMBER  
**L-01**  
© 2017 Harman Professional

# Auditorium Hybrid

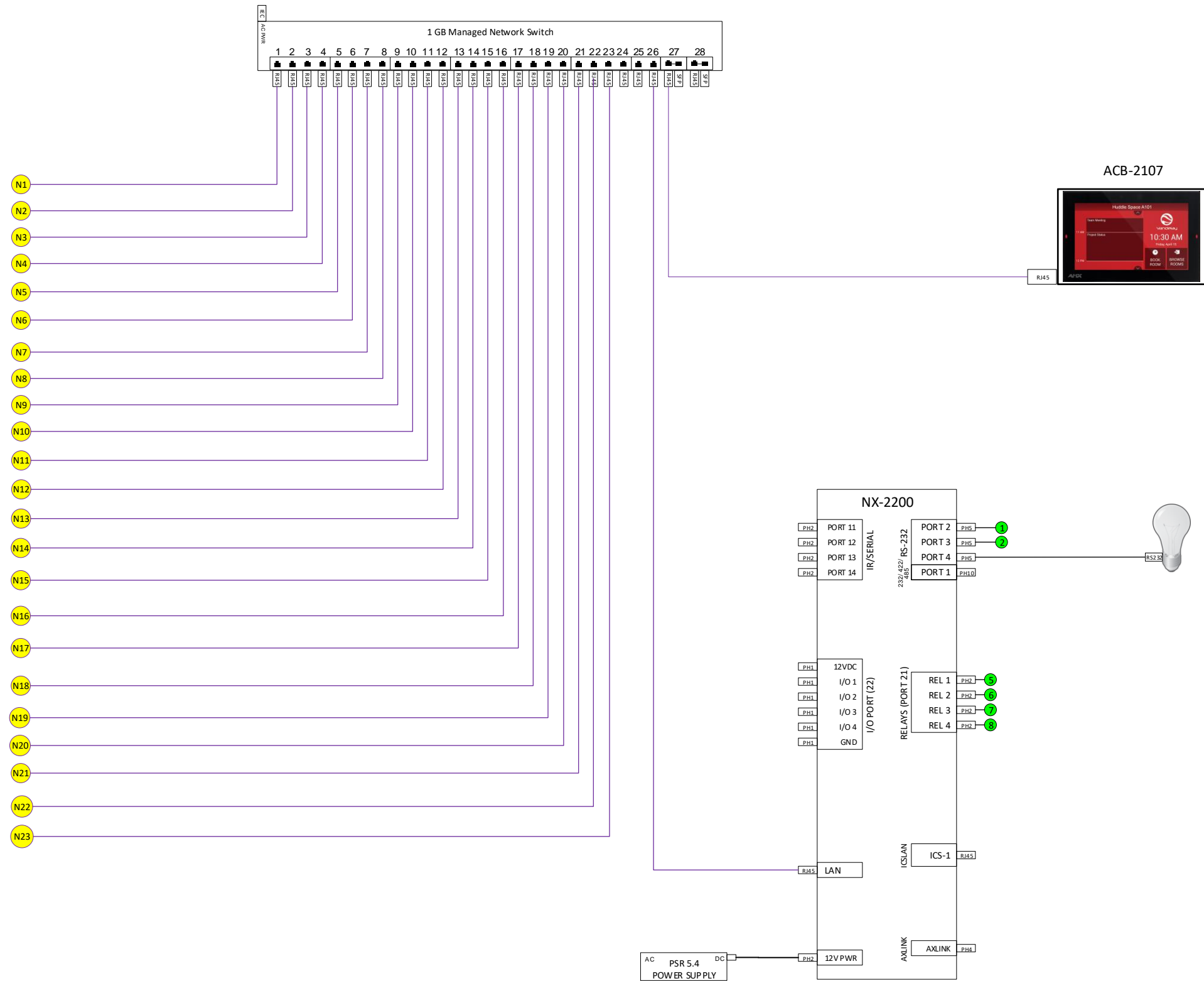

### Notes

Notes	Rev	DATE
Initial	0	8/31/17
ESS	1	7/11/18

ISSUE DATE: 9/1/2017

Legend	
HD MI	
DB15 VGA	
DXLINK	
AUDIO	
Blu Link	
BNC	
LAN	
Lighting XLS	
Control	
Control Tag	
Network Tag	
Audio Tag	
Video Tag	

PROJECT ENGINEER:  
DRAWN BY:

DRAWING NUMBER  
**C-01**  
© 2017 Harman Professional